

PHOTOELECTRIC BEAM DETECTOR

Photoelectric Triple Beam Detector User Manual (v2.2)

◆ Thanks for purchasing photoelectric triple beam detector, please read this user manual carefully before installation.

WARNING	Do not use the product for purposes other than the detection of moving objects such as people and vehicles. Do not use the product to activate a shutter etc. which may cause an accident. Do not touch the unit base or power terminals of the product with a wet hand (do not touch when the product is wet with rain etc.) It may cause electric shock.
CAUTION	Do not exceed the voltage or current rating specified for any of the terminals during installation, doing so may cause damage to the devices. Do not pour water over the product with a bucket, hose etc. The water may enter which may cause damage to the devices. Clean and check the product periodically for safe use. If any problem is found, do not attempt to use the product as it is and have the product repaired by a professional engineer or electrician.

1.Features

- Interruption time or walkspeed adjustable
- NO / NC relay outputs
- Integrated tamper switch, turns on when cover is moved.
- Frequencies selectable for long distance and stacking installations
- LED display signal grading for easy alignment
- Wide voltage power input: DC/AC 12-24V
- Waterproof grade: IP65
- Alignment angle horizontally $\pm 90^\circ$, vertically $\pm 10^\circ$
- Digital filtering, high environment adaptability to eliminate false alarms
- Integrated heating function, reliable in cold/frost/fog weather.

2.Part Description

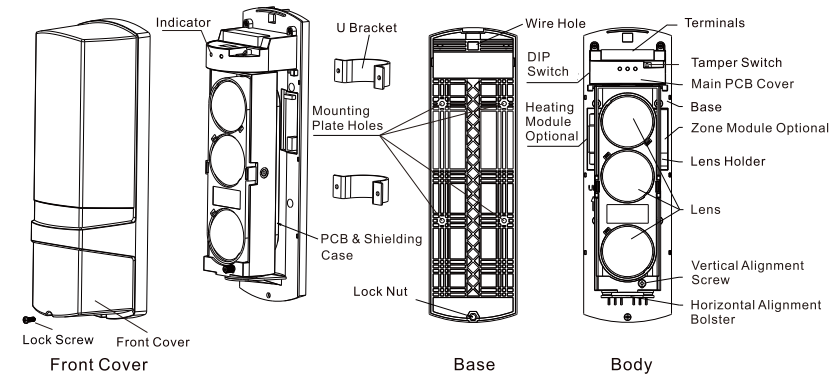

3.Installation Notes

(1).Please avoid below situations to assure performance

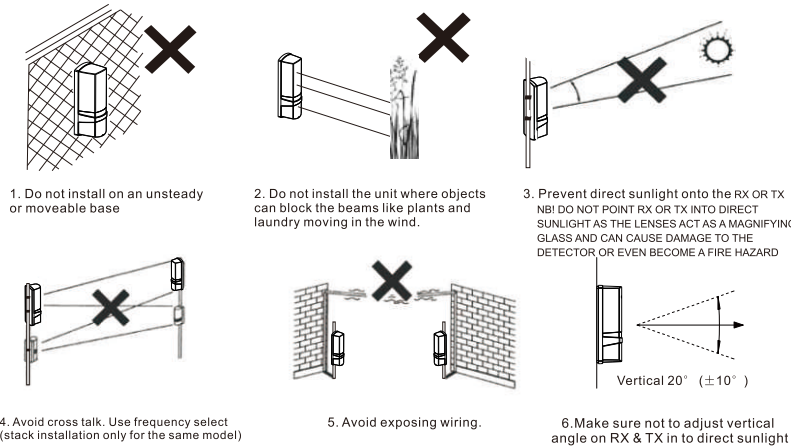

(2).Normal installation

◆ Detection distance

Detection Distance	50m	100m	150m	200m	250m
Beam Angle	1.6m	2.0m	2.6m	3.4m	4.4m

◆ Mounting height

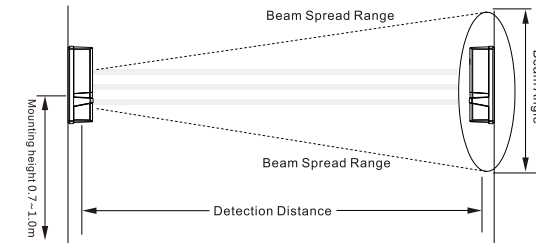

◆ Adjusting angle

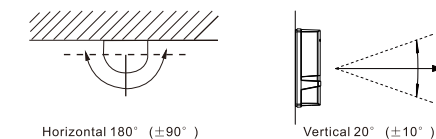

Notice: For best testing results, please avoid testing in 45°

4.Setting Method

◆ Wall mounting

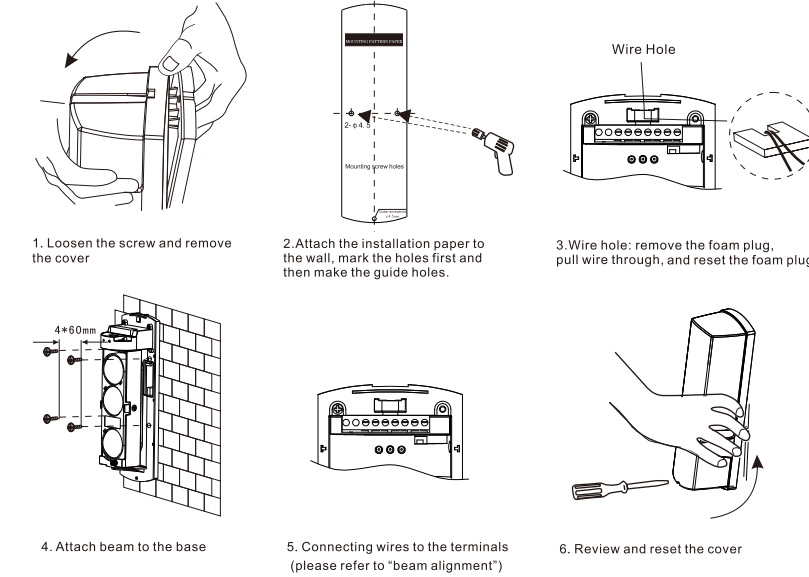

◆ Pole mounting

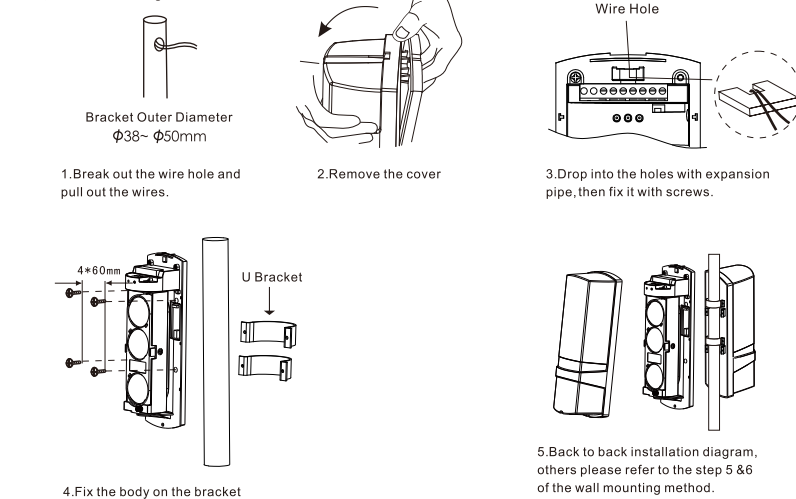

5.Connectors

Warning Do not exceed the voltage or current rating specified for any of the terminals during installation.

Transmitter:

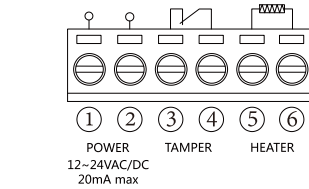

1. Power input: DC/AC12-24V.
2. No heater in the package, please order if required.
3. Tamper switch (NC) is independent of the circuit, anti-tamper trigger when cover is removed.

Receiver:

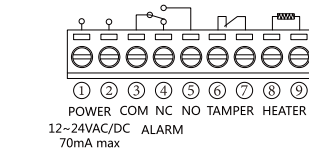

1. Power input: DC/AC12-24V.
2. No heater in the package, please order if require
3. Tamper switch (NC) is independent of the circuit, anti-tamper trigger when cover is removed.
4. C relay (30VDC 1.0A max).

6.Connecting Wires

(1).Single connect: Control panel operating voltage DC12V, NC alarm output. Connecting to power supply parallel

(2).Stacked connect: Control panel operating voltage DC12V,NC alarm output series connect

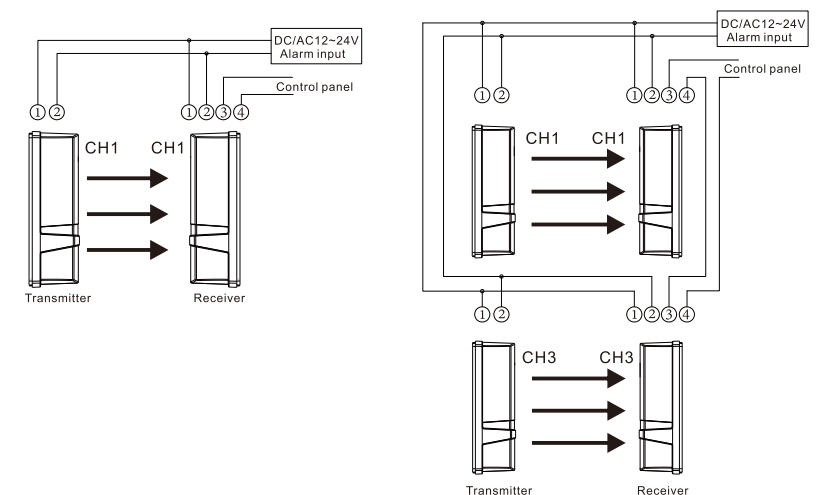

(3), 2 pairs install in series: Connect power of transmitter and receiver in series with 12V DC on power supply. Alarm output is N.C.

As below:

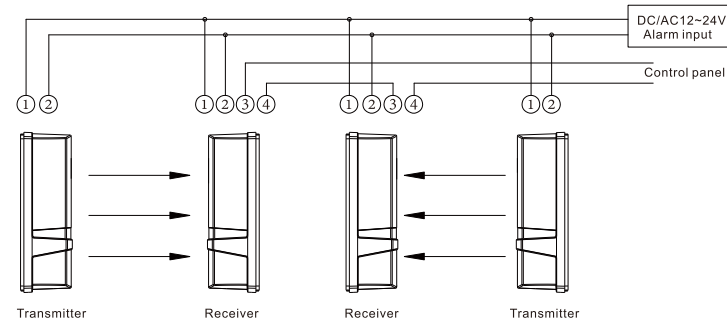

Wiring distance between the power supply and the detector should not exceed the following table length.

Wire diameter	Length	DC12V	DC24V
0.5mm ² (Φ0.8)		100m	500m
0.75mm ² (Φ1.0)		150m	750m
1.0mm ² (Φ1.2)		200m	1000m
1.5mm ² (Φ1.4)		250m	1250m

- Warning**
- The power wire can't exceed the listed length.
 - When connecting multiple detectors, the required cable length is divided by the corresponding number of units listed.
 - Don't connect the port with the voltage or current which is over the normal specification.



7. DIP Switch Explanations

1. DIP switch show on the left side of the main PCB, as shown in following figure.

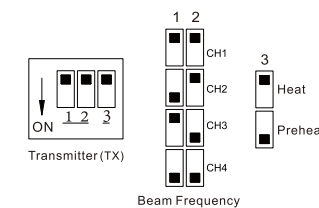

- DIP switches 1&2: Set beam frequency. TX and RX must be the same.
- DIP switch 3: Set heater. Preheat is for test. If the heater is installed, keep it on Heat position for normal use.

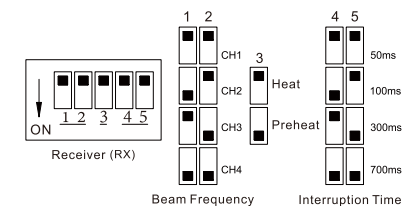

- DIP switches 1&2: Set beam frequency. TX and RX must be the same.
- DIP switch 3: Set heater. Preheat is for test. If the heater is installed, keep it on Heat position for normal use.
- DIP witches 4&5: Set interruption time. 50/100/300/700ms optional.

2. Indicators

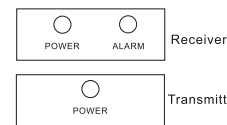

POWER (GREEN)

- Indicator turns on if TX and RX are powered, it will be off automatically after 30min.
- Indicator of RX turns on if alarm activated.
- Indicator turns on if power-on again.

ALARM (RED)

- ALARM indicator is always lighting if alarm activated; It will be off during arming.

8. Optic Axis Adjustment

- Set TX and RX same frequency by DIP switches 1&2.
- Adjust the beams vertically and horizontally, it is well aligned if LED shows "99".
- Do "walk test" to ensure it'll activate alarm normally. If failed, please re-do alignment. If alignment keeps failing, please refer to troubleshooting.

Signal strength	00-40 Realign 41-70 Fair 71-90 Good 91-99 Best
-----------------	---

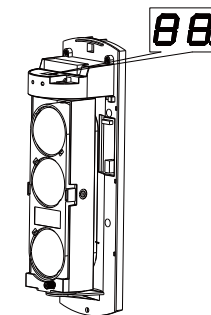

9. Walk Test

<p>Alarm Status</p>	Please make sure the alarm indicator is off before testing. If not, redo the alignment.
<p>Transmitter</p>	Please do the test at the 3 following positions 1. At the transmitter side 2. At the receiver side 3. In the middle
<p>Alarm Status</p>	Alarm indicator turns on when beam is interrupted, test finished successfully.

Note: If the alarm LED indicator is OFF even though the beams are completely blocked, refer to the "Trouble Shooting".

10. Troubleshooting

Symptom	Possible cause	Remedy
Power on, but power LED off	<ol style="list-style-type: none"> No voltage on power cable; Broken circuit or short circuit; Beyond specified voltage; Power cable exceeds the specified length 	<ol style="list-style-type: none"> Check PSU, voltage, cables and connectors
When beam is blocked, the alarm LED does not indicate, nor does the alarm relay switch	<ol style="list-style-type: none"> There is reflection or cross-talk from other transmitters Walk speed set too long Alarm output cable is shorted or damaged 	<ol style="list-style-type: none"> Change beam path or change TX/RX frequency channel Ensure 3 beams all blocked Change walk-speed setting Check RX terminal and output cable
When beam is not blocked, alarm LED indicates activation	<ol style="list-style-type: none"> Beam is out of alignment; optical axis does not overlap There are objects between TX and RX Frequency is incorrect The cover is dirty or capped by snow, frost and ice TX is faulty or OFF 	<ol style="list-style-type: none"> Adjust optical axis Check objects between TX and RX Ensure the frequency of TX and RX is the same Clean cover or user heater Check the voltage or wiring of TX
False alarm	<ol style="list-style-type: none"> Bad wiring and fluctuant power voltage Randomly blocked, like birds, paper or leaves The beams base is unstable Out of alignment 	<ol style="list-style-type: none"> Check power, current and wiring voltage Change installation location Strengthen installation base Re-align

11. Specifications

Detection distance	Outdoor	50m	100m	150m	200m	250m
	Indoor	150m	300m	450m	600m	750m
Detection method	Simultaneous interruption of 3 infrared beams					
Interruption time	50ms, 100ms, 300ms, 700ms (adjustable)					
Frequencies	4 different frequencies (selectable)					
Power and voltage	DC/AC12V-24V					
Current consumption	70mA max	80mA max	90mA max	100mA max	110mA max	110mA max
Alarm cycle	≥1.5s					
Alarm output	1C. relay output (AC/DC30V, 1.0A max)					
Tamper	NC. works when cover is removed					
IP rating	IP65					
Operating temperature	-25°C ~ 55°C					
Humidity	95% max					
Correction angle	Horizontal 180°(±90°), Vertical 20°(±10°)					
Install location	Indoor/Outdoor, Wall/Pole					
Weight	1670g					
Attachment	U bracket	4pcs, 70.4*37.5*21.5mm, δ=1.5mm, stainless steel				
	Pole mounting screw	8pcs, PM4*30mm				
	Wall mounting screw	8pcs, PM4*25mm				
	Expansion pipe	8pcs, Φ7*27mm, green				
Installation paper	2pcs, W85*H220mm					
	Voltage	12V-24V DC/AC				
Heaters (additional purchase)	Current	200mA max				
	Temperature	+60°C				
Working condition	Auto Heating when it's ≤5°C and stop heating when it's ≥7°C					

Note: When environment temperature lower than -20°C, please use heaters to ensure normal working. Heater is non-polarized.

12. Dimensions

